

hib.

Installation Guide Turbo Ventilation Range

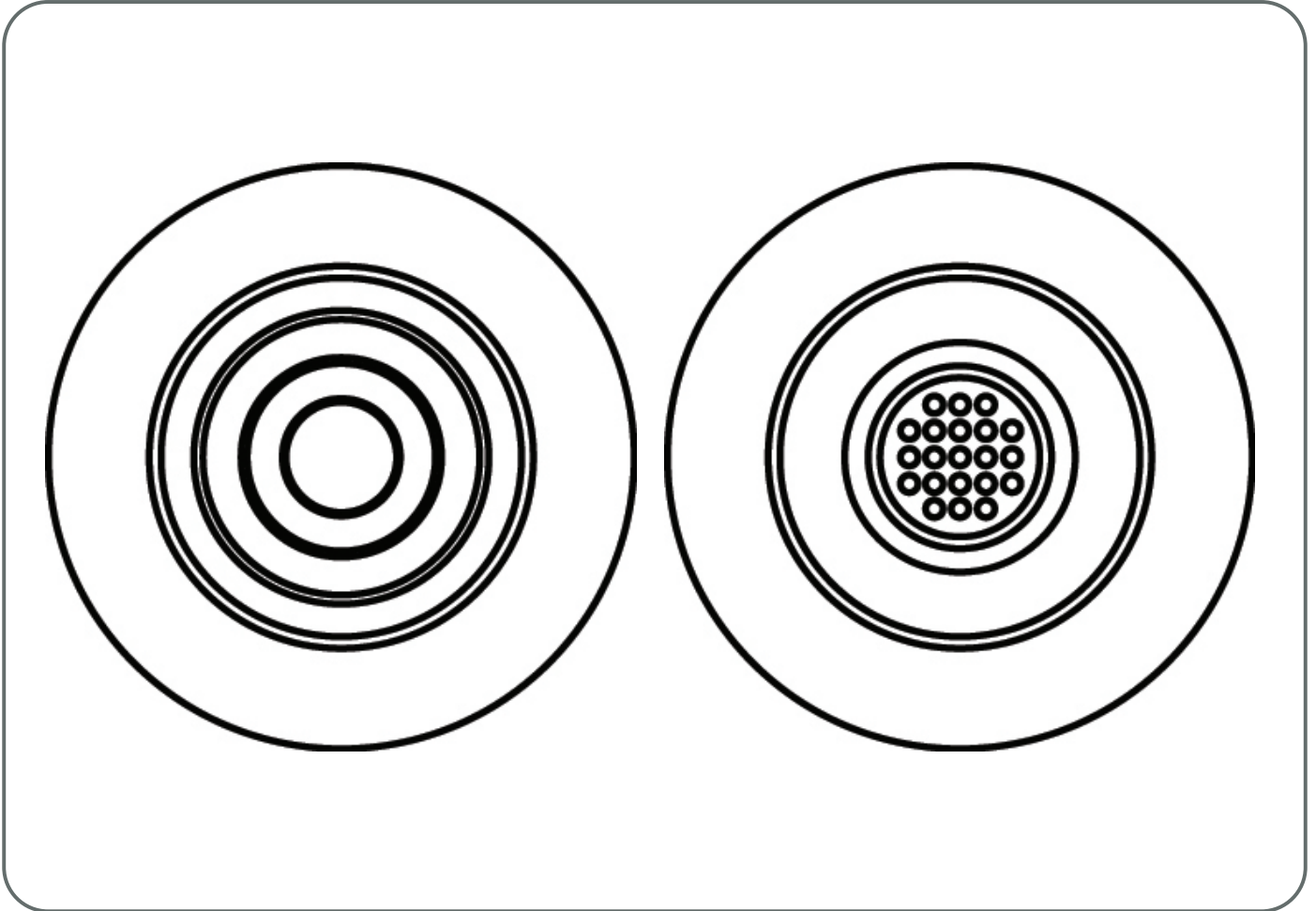

Thank you for purchasing this hib. product

Please read through these instructions carefully and refer back to them during installation to ensure that your product is fitted safely and that it retains its high quality finish.

Please retain this installation guide for future reference

Turbo Chrome Non-Illuminated
33600

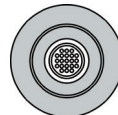
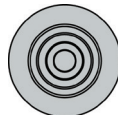

Turbo Chrome Illuminated
Cool White: 32300 Warm White: 33900

Turbo White Non-Illuminated
33500

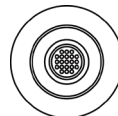

Turbo White Illuminated
Cool White: 32200 Warm White: 34000

Components - What's in the Box

- High Powered Inline Fan
- 3 Metre Flexible Ducting
- White External Fixed Grille
- Plastic Screwdriver
- Screw & Dowels Pack
- Galvanised Steel Hose Clamps x4
- Fascia
- LED Driver (Illuminated Vents)
- Foam Strip

Electrical Zoning Diagram & Safety Information

This product contains a light source of energy efficiency **Class E**

This product is IP44 rated and suitable for installation in **Zone 2** and **Outside Zone**

Fig. 1 Zonal Diagram



We recommend that all electrical bathroom products should only be fitted by a suitable, qualified, Part P registered electrician. Ensure mains power supply is switched off before starting installation. Before drilling, ensure there are no hidden cables or pipes in the wall.

The Turbo Illuminated Inline Fans are supplied with a 5 Watt LED Lamp. **DO NOT** replace with any other lamp as this will invalidate any warranty. **DO NOT** exceed the stated wattage.

Once the fan is powered, it may turn on straight away. This is because the fan has a capacitor and holds an initial charge.

All installations must comply with guidelines which are based on a zonal concept above and must be followed to ensure the safe installation of electrical appliances in the bathroom. These regulations apply to domestic installations only. Installations must be made in accordance with the current IEE wiring regulations and relevant building regulations.

Electrical Wiring Diagram

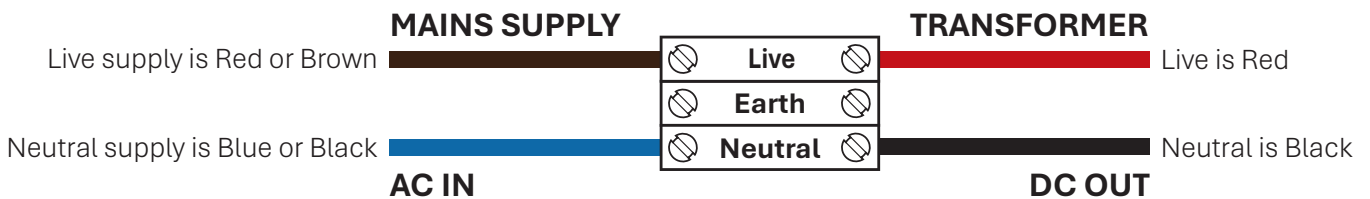

Timer System

The timer circuit is under mains Voltage. Ensure mains power supply is switched off before making any adjustments.

The fan is operated by turning on the wall switch. When the switch is turned off the fan will continue to operate within the set period of time. Adjustable between 2-30mins. This can be adjusted by turning the potentiometer T clockwise to increase and anti-clockwise to decrease the run time.

ONLY use the screwdriver provided to adjust the timer setting.



Mounting Fan Unit

Install the Turbo Inline fan within the loft or ceiling space, **DO NOT COVER** the motor or LED driver with loft insulation. The fan is **ONLY** suitable for horizontal mounting on a wall or floor. Follow the visual aids below to mount the Fan unit.

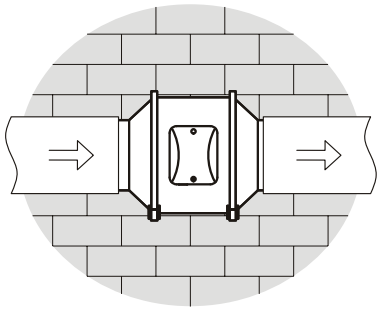

Fig. A horizontal on a wall

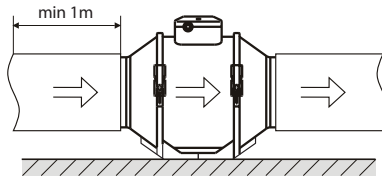
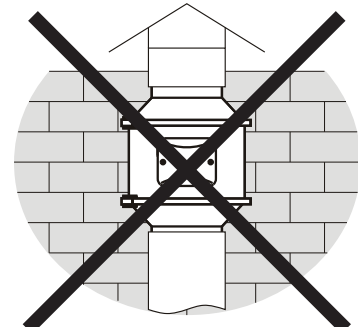

Fig. B horizontal on a floor



Do not mount vertically

Do not run the ducting over the joists, this will cause a build of condensation and reduce the extraction rate. Ensure the ducting is run between joists to create smooth airflow.

Electrical Connection

Ensure the mains power supply to which the fan is being connected to is turned off. This product is designed to be connected to an on/off switch outside the bathroom, or to a ceiling mounted pull cord switch. Please follow the visual aids below for wiring the fan.

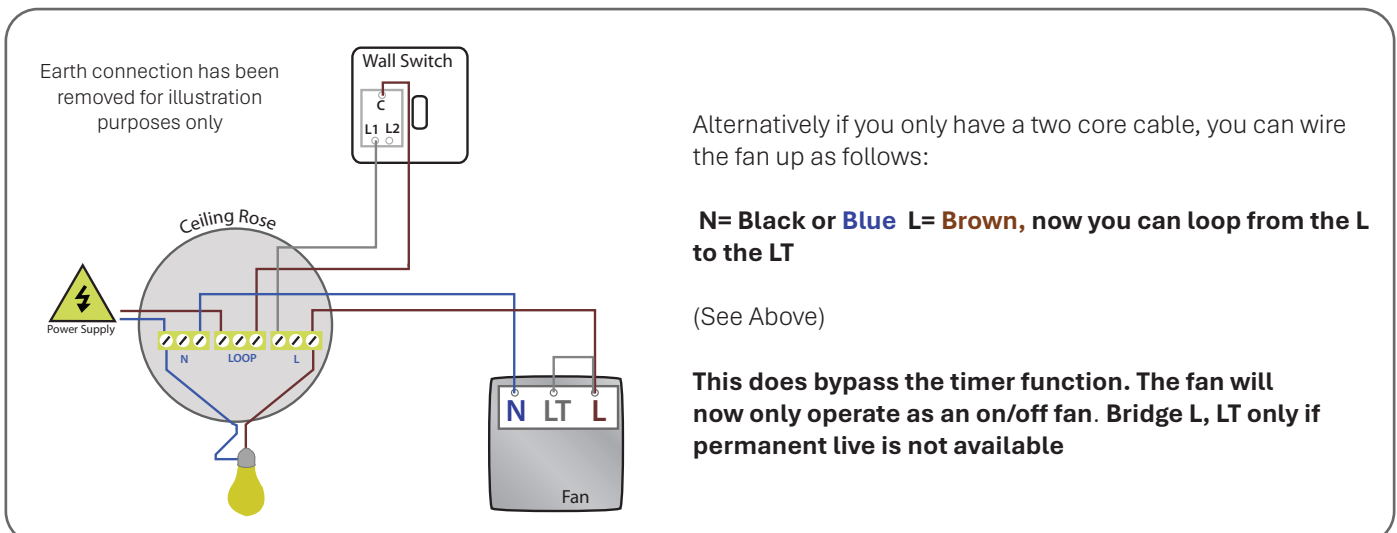
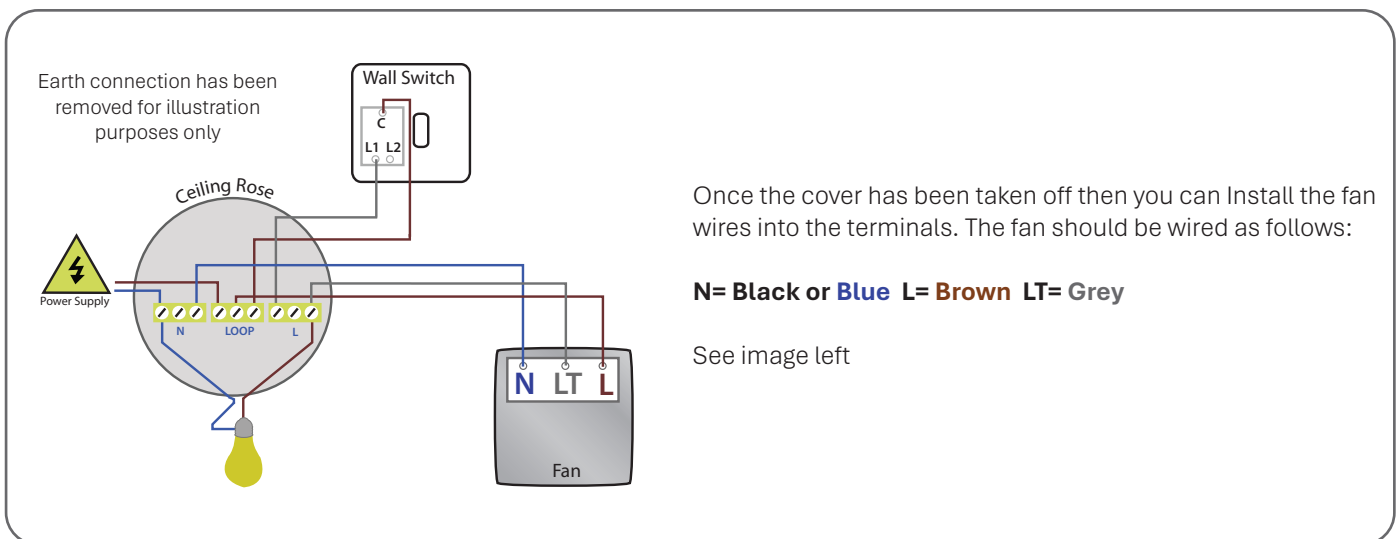

Mounting Fascia

1. The ventilation should be ducted through the roof space, ducting to an external soffit under the eaves or grille in the slope of your roof. **Ducting can only run between joists, not across them.**
2. Mark the position of the fascia with a pencil in a suitable position on the ceiling, making sure that it is between joists.
3. Drill a 9mm hole through the ceiling along the edge of the pencil line. Now cut out the hole with a pad saw.
4. Hold the fascia against the ceiling and mark the position of the fixing holes, fix the unit in place using suitable fixings (not supplied).
5. Attach the flexible ducting with the metal hose clamps. **Ensure the ducting has a smooth flow towards the motor body. Follow a similar procedure for the outside wall grille.** Extra ducting may be used to extend the distance to the external grille but the performance will be reduced.

Maintenance & Aftercare

In order to maintain the safe and effective operation of the fan regular maintenance must be performed. Fan maintenance is to be performed only after the fan is disconnected from the mains power supply. This includes periodic cleaning of the surface of dust and dirt.

All surfaces should be cleaned with a diluted detergent and a soft cloth. Avoid water dripping on the electric components. Wipe the surfaces dry after cleaning.

Aftercare service: In the unlikely event that this product should fail, please contact HiB customer services. The details are shown below.



WEEE compliance

Must not be mixed with
general household waste

T: +44 (0)20 8441 0352 E: sales@hib.co.uk hib.co.uk
Building 3, North London Business Park, Oakleigh Road South, New Southgate, London. N11 1GN.
3rd Floor, 40 Mespil Road, Dublin 4. DO4 C2N4.

©hib. Copyright: No part of this document may be reprinted or duplicated without hib. consent. All sizes and measurements are approximate, but we do try and make sure they are as accurate as possible. In the interest of continuous product development, hib. reserves the right to alter specifications as necessary. E & OE.